

Panasonic

Before connecting, operating or adjusting this product, please read these instructions completely. Please keep this manual for future reference.

Stereo Radio Cassette Player Model No. RQ-SW99V RQ-SW88V

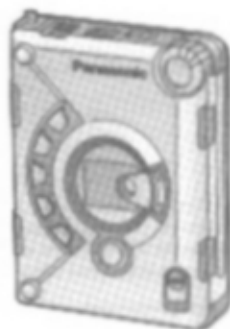

Operating Instructions

[P1]

The serial number of this product can be found inside of the battery compartment.

Please note them in the space provided below and keep as a permanent record of your purchase to aid identification in the event of theft.

MODEL NUMBER _____

SERIAL NUMBER _____

(En)

Panasonic Consumer Electronics Company,
Division of Matsushita Electric Corporation of
America

One Panasonic Way Secaucus, New Jersey 07094
<http://www.panasonic.com>

Panasonic Sales Company, Division of
Matsushita Electric of Puerto Rico, Inc. ("PSC")

Ave. 65 de Infantería, Km. 9.5 San Gabriel Industrial
Park, Carolina, Puerto Rico 00985

©2000 Matsushita Electric Industrial Co., Ltd.

Printed in Taiwan

RQT00383-F
F0100RKC

Basic Operation (From the main unit)

TAPE PLAYBACK

You can use normal position type tapes only.

Function	[MAIN, SUB, HOLD] Selector	Operation
Stop	[MAIN] ▶	During playback, press [2, OFF ■].
Fast forward (FF) or rewind (REW)*	[MAIN] ▶	In the stop mode, press [3, FF/+] or [4, REW/-].
Tape Program Sensor (TPS)* You can skip as many programs as the number of times (up to 3) the button is pressed.	[MAIN] ▶	During playback, press [3, FF/+] or [4, REW/-].
Reverse tape direction	[MAIN] ▶	During playback, press [1, TAPE ◀▶].

*To switch to playback during FF, REW or TPS
Press [1, TAPE ◀▶].

RADIO RECEPTION

Function	[MAIN, SUB, HOLD] Selector	Operation
Off	[MAIN] ▶	During reception, press [2, OFF ■].

Troubleshooting Guide

Before requesting service for this unit, check the chart for a possible cause of the problem you are experiencing. Some simple checks or a minor adjustment on your part may eliminate the problem and restore proper operation.

If you are in doubt about some of the check points, or if the remedies indicated in the chart do not solve the problem, refer to the directory of Authorized Service Centers (enclosed with this unit) to locate a convenient service center, or consult your dealer for instructions.

For detailed instructions, contact an authorized servicenter 1-800-211-7262 or web site (<http://www.panasonic.com>).

BEFORE CALLING



1 INSTALL A BATTERY.

One R6/LR6, AA, UM-3 (not included) battery

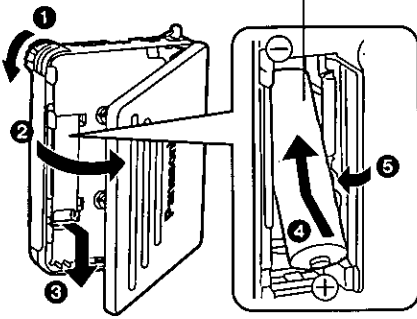

2 CONNECT THE HEADPHONES.

Plug type:
3.5 mm (1/8") stereo

Plug in firmly.

< RQ-SW99V >



< RQ-SW88V >



Remote control

3

BATTERY CONDITION

In the stop mode

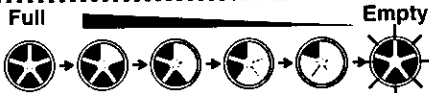

CHANGING THE BASS

While playing a tape or FM radio with selector to [MAIN]



< RQ-SW99V >

"S-XBS" → "VMSS"
↑ " " (OFF) ↓

< RQ-SW88V >

"S-XBS" → " " (OFF) ←

TAPE



① SET THE SELECTOR TO [MAIN].



② INSERT A CASSETTE.

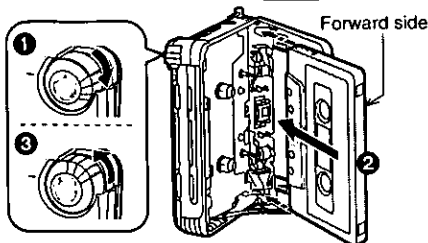

③ PRESS [1, TAPE ◀▶].

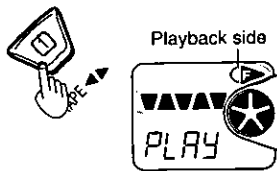

ADJUST THE VOLUME.

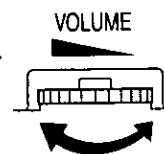

③ SELECT THE STATION.

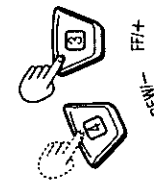

RADIO



① SET THE SELECTOR TO [MAIN].

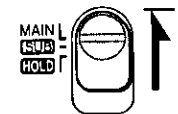

② SELECT THE BAND.



■ How to use the remote control

Before using the volume on the remote control, adjust [VOLUME] on the main unit so the numbers "5", "6", or "7" can be seen on the control.

Before operation, be sure to release hold.

< RQ-SW99V >

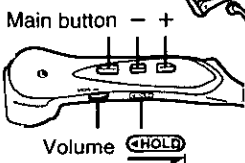

< RQ-SW88V >

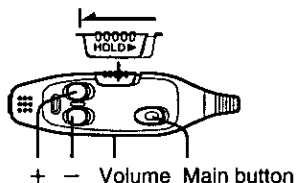

Press. Press and hold.

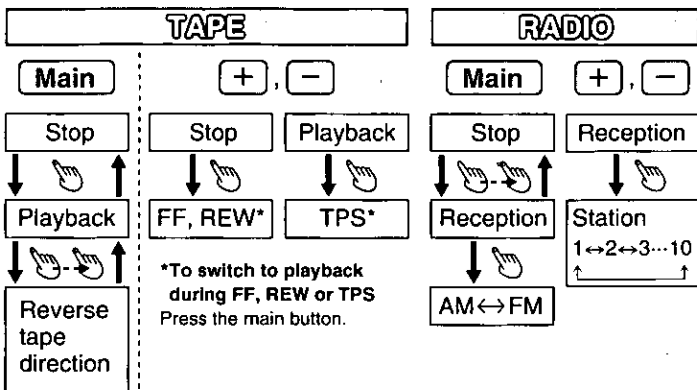

PROBLEM

Radio operates but tape doesn't.

No operations.

- No sounds.
- VMSS does not function. (RQ-SW99V only)
- A gritty noise is heard.

VMSS is not working very well. (RQ-SW99V only)

Cannot hear music—too noisy.

CHECKPOINT

Is the battery worn?

- Is the unit in the hold state?
- Has the battery been installed with its polarities (+, -) reversed?

- Is the headphone plug firmly connected to the \odot jack?
- Is the plug dirty?

Is the volume down too low? (The VMSS system functions better when the volume is at a higher level.)

Separate the unit from mobile phones.

Supplied Accessories

Carrying case	RFC0056-K
Stereo headphones with remote control (RQ-SW99V only)	RFEV506P
Stereo headphones (RQ-SW88V only)	RFEV712P
Remote control (RQ-SW88V only)	RFEV015PCKS
Neck strap	RKHT0003-Y

•To order accessories contact 1-800-332-5368 or web site (<http://www.panasonic.com>).

•Use numbers indicated when asking for replacement parts.

Be sure to give the model number and color of the unit when purchasing replacement headphones.

Attaching the neck strap (included)

The unit is easier to carry around if you attach the neck strap.

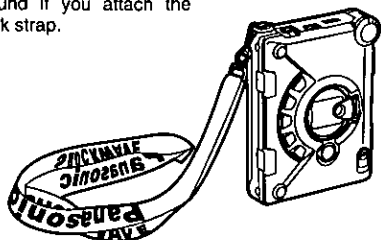

CAUTION:

This equipment has been tested and found to comply with the limits for a Class B digital device, pursuant to Part 15 of the FCC Rules.

These limits are designed to provide reasonable protection against harmful interference in a residential installation. This equipment generates, uses and can radiate radio frequency energy and, if not installed and used in accordance with the instructions, may cause harmful interference to radio communications. However, there is no guarantee that interference will not occur in a particular installation. If this equipment does cause harmful interference to radio or television reception, which can be determined by turning the equipment off and on, the user is encouraged to try to correct the interference by one of the following measures:

- Reorient or relocate the receiving antenna.
- Increase the separation between the equipment and receiver.
- Connect the equipment into an outlet on a circuit different from that to which the receiver is connected.
- Consult the dealer or an experienced radio/TV technician for help.

Any unauthorized changes or modifications to this equipment would void the user's authority to operate this device.

This device complies with Part 15 of the FCC Rules. Operation is subject to the following two conditions: (1) This device may not cause harmful interference, and (2) this device must accept any interference received, including interference that may cause undesired operation.

RADIO



To obtain better reception

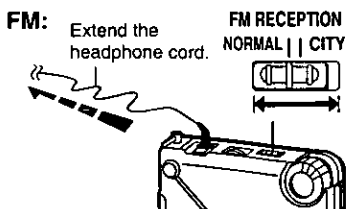

How to receive an FM broadcast clearly
Set [FM RECEPTION] to [NORMAL].
When the FM reception is impaired, or there is interference from a powerful station, set it to [CITY].

AM:



■ When a station is tuned in



Preset tuning

Frequencies of up to 20 radio stations (10 each for AM and FM) can be stored in the memory.

■ Memory presetting

(Available only from the main unit)

1. Tune in the station to be stored.
2. Set [MAIN, SUB, HOLD] to [SUB].
3. Press and hold one of the memory buttons ([1], [2], [3], [4], [5]) for about 2 seconds.

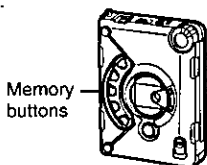

3 beeps can be heard.



To select a memory channel from 6 to 10
1. Press [BATT CHECK +5].

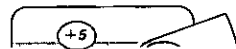

2. Within 10 seconds press and hold one of the memory buttons for about 2 seconds.
For example (Memory channel 7):
[BATT CHECK +5] → [2]

■ To recall a preset station (From the main unit)

1. Set [MAIN, SUB, HOLD] to [SUB].
2. Press a memory button.
To select a memory channel from 6 to 10, press [BATT CHECK +5] and within 10 seconds press a memory button.
● Release the memory button within 2 seconds.

(From the remote control)

During reception, press [+] or [-].

Note:

Pressing [BATT CHECK +5] while "+5" is displayed clears it.

When using overseas

Allocations need to be changed according to the area.

Every time the following procedure is performed, the allocation setting changes as follows:

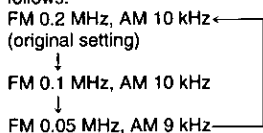

■ How to adjust the allocation settings

(Available only from the main unit)

While playing the radio

1. Set [MAIN, SUB, HOLD] to [MAIN].
2. While pressing [BATT CHECK +5], press and hold [5, RADIO ON/BAND] for about 3 seconds.

● The changed allocation settings (FM and then AM) are displayed.

Note:

Converting the allocation erases the stations previously stored in memory.

BASS



VMSS (RQ-SW99V only) or S-XBS does not function for AM reception.

If you press [BATT CHECK +5, VMSS/S-XBS] (RQ-SW99V) or [BATT CHECK +5, S-XBS] (RQ-SW88V) during AM reception, "E." is shown on the display.

VMSS (RQ-SW99V only)

Boosts the low frequency range.

The VMSS unit of the included headphones vibrate, making the sound seem more vigorous.

Raising the volume intensifies the effect.

VMSS unit



● The effect may be reduced with some sources.

● The best effect is obtained by allowing the VMSS unit to directly contact the neck. Depending on how the unit is worn, the effect can be reduced.

● If you experience a ringing or discomfort in your ear while listening in VMSS mode, reduce volume or turn the VMSS mode OFF.

S-XBS

Boosts the low frequency range.

● If distortion occurs, turn down the volume.

HOLD



Concerning the hold function

This function prevents the unit from operating inadvertently.

● The function on the main unit and the remote control are independent of each other.

During hold state on the main unit



If a button on the main unit is pressed...

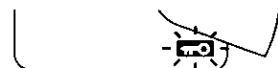

BATTERY



- Align the poles (+ and -) properly when inserting the batteries.
 - Do not recharge ordinary dry cell batteries.
 - Remove the batteries if the unit is not to be used for a long time.
 - Do not use the batteries if the covering has been peeled off.
- Mishandling of batteries can cause electrolyte leakage which can damage items the

fluid contacts and may cause a fire. If electrolyte leaks from the batteries, consult your dealer.
Wash thoroughly with water if electrolyte comes in contact with any part of your body.
• If rechargeable batteries are to be used, rechargeable batteries manufactured by Panasonic are recommended.

Battery condition indicator

The indicator is shown whenever the radio is on or a tape is traveling.

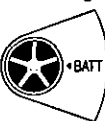

- When you start a tape or radio reception, the indicator scrolls 2 times before it lights.
- When you press [BATT CHECK +5] in the stop mode, the indicator scrolls 2 times and lights for about 5 seconds.
- The indicator may show a lower amount of charge during some operations.

When the battery is weak
The indicator will flash and then:

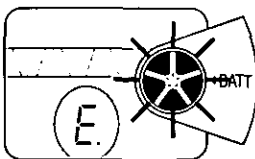

- Leaving the unit in this condition erases the contents of the memory.
Replacing the batteries within 30 seconds will retain any stored information.

CAUTION



- Avoid using or placing this unit near sources of heat. Do not leave it in an automobile exposed to direct sunlight for a long period of time with doors and windows closed.
- To avoid product damage, do not expose this product to rain, water or other liquids.

Caution when using the included headphones (RC-SW99V only)

- Do not wear the headphones with the VMSS unit to the front.
- Do not allow children or people who are unwell or not in full control of their faculties to wear these headphones.
- If you feel nauseous while using the headphones, discontinue use immediately.

Listening caution



Do not play your headphones or earphones at a high volume. Hearing experts advise against continuous extended play. If you experience a ringing in your ears, reduce volume or discontinue use. Do not use while operating a motorized vehicle. It may create a traffic hazard and is illegal in many areas. You should use extreme caution or temporarily discontinue use in potentially hazardous situations. Even if your headphones or earphones are the open-air type designed to let you hear outside sounds, don't turn up the volume so high that you can't hear what's around you.

Sound can be deceiving. Over time your hearing "comfort level" adapts to higher volumes of sound. So what sounds "normal" can actually be loud and harmful to your hearing.

Guard against this by setting your equipment at a safe level BEFORE your hearing adapts.

To establish a safe level:

- Start your volume control at a low setting.
- Slowly increase the sound until you can hear it comfortably and clearly, and without distortion.

Once you have established a comfortable sound level:

- Set the dial and leave it there.

MAINTENANCE



If the surfaces are dirty

To clean this unit, wipe with a soft, dry cloth.

If the surfaces are extremely dirty, use a soft cloth dipped in a soap-and-water solution or a weak detergent solution.

• Never use alcohol, paint thinner or benzene to clean this unit.

• Before using chemically treated cloth, read the instructions that came with the cloth carefully.

For a cleaner crisper sound

Clean the heads regularly to assure good quality playback.

Use a cleaning tape(not included).

TAPE



When the cassette holder is closed

Playback will be ready to start from the forward side.

Auto reverse

Unless [2, OFF] is pressed, the unit plays 3 sides of the tape and then automatically stops.

Note:

• When closing the cassette holder, be sure to push the cassette holder firmly against the unit, and turn [OPEN, LOCK] until it locks.

• Do not open the cassette holder during tape operation.

Product Service

Do not attempt to remove the cover(s) or repair the unit yourself. Refer servicing to qualified personnel only.

Product information

For product service, product information or assistance with product operation, refer to the servicenter directory.

User memo:

DATE OF PURCHASE	_____
DEALER NAME	_____
DEALER ADDRESS	_____
TELEPHONE NUMBER	_____

Technical Specifications

Radio frequency range: FM; 87.9–107.9 MHz
(0.2 MHz steps)
87.5–108.0 MHz
(0.1 MHz/0.05 MHz steps)
AM; 520–1710 kHz (10 kHz steps)
522–1629 kHz (9 kHz steps)

Frequency range: 40–18000 Hz (Normal)

Tape speed: 4.8 cm/s (1 7/8 ips)

Jack: Output; HEADPHONES

Power requirement: Battery; DC 1.5 V
(R6/LR6, AA, UM-3 battery)

Dimensions (W×H×D): 81.1×111.3×28.5 mm (3 1/8"×4 3/8"×1 1/8")

Mass (without battery): 180 g (6.3 oz.)

Play time:

[When used in hold mode, at 25°C (77°F) on a flat, stable surface]
Panasonic alkaline dry cell battery; Tape; About 28 hours
Radio; About 32 hours

•The play time may be less depending on the operating conditions.

Note: Specifications are subject to change without notice. Mass and dimensions are approximate.

Panasonic Consumer Electronics Company, Division of Matsushita Electric Corporation of America
One Panasonic Way,
Secaucus, New Jersey 07094

Panasonic Audio Products Limited Warranty

Panasonic Sales Company, Division of Matsushita Electric Corporation of Puerto Rico, Inc.
Ave. 65 de Infantería, Km. 9.5
San Gabriel Industrial Park,
Carolina, Puerto Rico 00985

Panasonic Consumer Electronics Company or Panasonic Sales Company (collectively referred to as "the warrantor") will repair this product with new or refurbished parts in the event of a defect in materials or workmanship, free of charge, in the U.S.A. or Puerto Rico as follows (all time periods start from the date of original purchase) :

COMPACT DISC PLAYERS, RADIOS, VIDEO CD PLAYERS, RADIO CASSETTE PLAYERS/RECORDERS (with and without CD Players), CASSETTE RECORDERS, MICROCASSETTE RECORDERS/TRANSCRIBERS AND IC RECORDERS—labor and parts for one (1) year.

ACCESSORIES—HEADPHONES, CARTRIDGES, MICROPHONES, ADAPTERS—labor and parts for ninety (90) days.

BATTERIES—(when applicable)—New rechargeable batteries in exchange for defective rechargeable batteries for ten (10) days. Non-rechargeable batteries are not warranted.

RECHARGEABLE BATTERY PACKS—(when applicable)—New rechargeable battery packs in exchange for defective rechargeable battery packs for ninety (90) days. Non-rechargeable battery packs are not warranted.

Carry-in or mail-in service in the U.S.A. can be obtained during the warranty period by contacting a Panasonic Services Company (PASC) Factory Servicenter listed in the Servicenter Directory. Or call toll free, 1-800-211-7262 to locate a PASC authorized Servicenter. Carry-in or mail-in service in Puerto Rico can be obtained during the warranty period by calling the Panasonic Sales Company telephone number listed in the Servicenter Directory.

This warranty is extended only to the original purchaser. A purchase receipt or other proof of date of original purchase will be required before warranty service is rendered.

This warranty only covers failures due to defects in materials and workmanship which occur during normal use and does not cover normal wear to the stylus

(when applicable) or a dealer installed cartridge or stylus. The warranty does not cover damages which occur in shipment or failures which are caused by products not supplied by the warrantor, or failures which result from accident, misuse, abuse, neglect, mishandling, faulty installation, misapplication, set-up adjustments, maladjustment of consumer controls, improper operation or maintenance, improper antenna, inadequate signal reception or pick-up, alteration, modification, power line surge, improper voltage supply, lightning damage, commercial use, such as; hotel, office, restaurant, or other business or rental use of the product, or service by anyone other than a PASC Factory Servicenter or a PASC authorized Servicenter, or damage that is attributable to acts of God.

LIMITS AND EXCLUSIONS

There are no express warranties except as listed above.
THE WARRANTOR SHALL NOT BE LIABLE FOR INCIDENTAL OR CONSEQUENTIAL DAMAGES RESULTING FROM THE USE OF THIS PRODUCT, OR ARISING OUT OF ANY BREACH OF THIS WARRANTY, INCLUDING WITHOUT LIMITATION, DAMAGE TO TAPES, RECORDS OR DISCS. ALL EXPRESS AND IMPLIED WARRANTIES, INCLUDING THE WARRANTIES OF MERCHANTABILITY, AND FITNESS FOR A PARTICULAR PURPOSE, ARE LIMITED TO THE APPLICABLE WARRANTY PERIOD SET FORTH ABOVE. Some states do not allow the exclusion or limitation of incidental or consequential damages, or limitations on how long an implied warranty lasts, so the above exclusions or limitations may not apply to you.

This warranty gives you specific legal rights and you may also have other rights which vary from state to state.

If a problem with this product develops during or after the warranty period, you may contact your dealer or Servicenter. If the problem is not handled to your satisfaction, then write to the Panasonic Consumer Call Center at the company address above or call toll free 1-800-211-7262.

If you ship the product

Carefully pack and send it prepaid, adequately insured and preferably in the original carton.
Attach a postage-affixed letter, detailing the complaint, to the outside of the carton.

Do NOT send the product to the Executive or Regional Sales offices. They are NOT equipped to make repairs.

Customer's Record

Model No. _____	Dealer's Name _____
Serial No. _____ or _____	_____
Code No. _____	Dealer's Address _____
Date of Purchase _____	_____